

ISL3178AE

±15kV ESD Protected, 3.3V, Full Fail-Safe, Low Power, High Speed or Slew Rate Limited, RS-485/RS-422 Transceivers

FN6887
Rev 3.00
October 30, 2014

The Intersil ISL3178AE is ±15kV IEC61000 ESD protected, 3.3V-powered, single transceiver that meets both the RS-485 and RS-422 standards for balanced communication. This device has very low bus currents (+125µA/-100µA), which presents a true “1/8 unit load” to the RS-485 bus. This allows up to 256 transceivers on the network without violating the RS-485 specification’s 32 unit load maximum, and without using repeaters. For example, in a remote utility meter reading system, individual meter readings are routed to a concentrator via an RS-485 network, so the high allowed node count minimizes the number of repeaters required.

Receiver (Rx) inputs feature a “Full Fail-Safe” design, which ensures a logic high Rx output if Rx inputs are floating, shorted, or terminated but undriven.

Hot Plug circuitry ensures that the Tx and Rx outputs remain in a high impedance state while the power supply stabilizes.

The ISL3178AE is a half duplex version. It multiplexes the Rx inputs and Tx outputs to allow transceivers with output disable functions in an 8 Ld package.

Related Literature

- [AN1475](#), “High Temperature Behavior of ISL3178AE”

Features

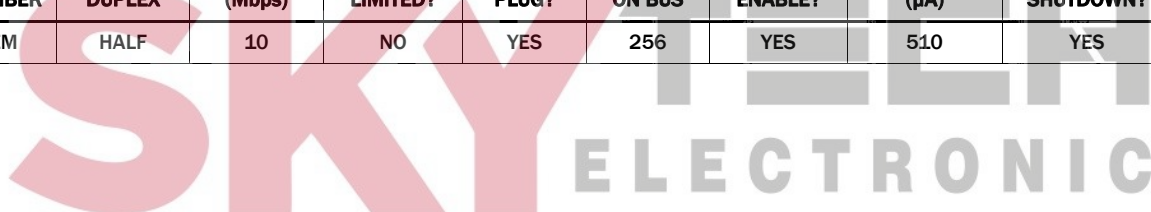
- IEC61000 ESD protection on RS-485 I/O pins ±15kV
- Class 3 ESD level on all other pins.....>7kV HBM
- Full fail-safe (open, short, terminated/floating) receivers
- Hot plug - Tx and Rx outputs remain three-state during Power-up
- True 1/8 unit load allows up to 256 devices on the bus
- Single 3.3V supply
- High data rates..... up to 10Mbps
- Low quiescent supply current..... 800µA (max)
- Ultra low shutdown supply current..... 10nA
- -7V to +12V common mode input/output voltage range
- Half duplex pinouts
- Three state Rx and Tx outputs available
- Current limiting for driver overload protection
- Pb-free (RoHS compliant)

Applications

- Automated utility meter reading systems
- High node count systems
- Field bus networks
- Security camera networks
- Building environmental control/ lighting systems
- Industrial/process control networks

TABLE 1. SUMMARY OF FEATURES

PART NUMBER	HALF/FULL DUPLEX	DATA RATE (Mbps)	SLEW-RATE LIMITED?	HOT PLUG?	# DEVICES ON BUS	RX/TX ENABLE?	QUIESCENT I _{CC} (µA)	LOW POWER SHUTDOWN?	PIN COUNT
ISL3178AEM	HALF	10	NO	YES	256	YES	510	YES	8



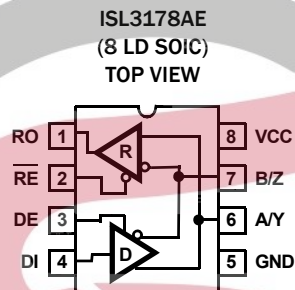
Ordering Information

PART NUMBER (Notes 1, 2, 3)	PART MARKING	TEMP. RANGE (°C)	PACKAGE (Pb-Free)	PKG. DWG. #
ISL3178AEMBZ	3178A EMBZ	-55 to +125	8 Ld SOIC	M8.15

NOTES:

1. Add "-T*" suffix for tape and reel. Please refer to [TB347](#) for details on reel specifications.
2. These Intersil Pb-free plastic packaged products employ special Pb-free material sets, molding compounds/die attach materials, and 100% matte tin plate plus anneal (e3 termination finish, which is RoHS compliant and compatible with both SnPb and Pb-free soldering operations). Intersil Pb-free products are MSL classified at Pb-free peak reflow temperatures that meet or exceed the Pb-free requirements of IPC/JEDEC J STD-020.
3. For Moisture Sensitivity Level (MSL), please see device information page for [ISL3178AE](#). For more information on MSL, please see tech brief [TB363](#)

Pin Configuration



Pin Descriptions

PIN #	PIN NAME	FUNCTION
1	RO	Receiver output: If $A-B \geq -50\text{mV}$, RO is high; If $A-B < -200\text{mV}$, RO is low; RO = High if A and B are unconnected (floating) or shorted.
2	$\overline{\text{RE}}$	Receiver output enable. RO is enabled when $\overline{\text{RE}}$ is low; RO is high impedance when $\overline{\text{RE}}$ is high. If the Rx enable function isn't required, connect $\overline{\text{RE}}$ directly to GND or through a $1\text{k}\Omega$ to $3\text{k}\Omega$ resistor to GND.
3	DE	Driver output enable. The driver outputs, Y and Z, are enabled by bringing DE high, and are high impedance when DE is low. If the Tx enable function isn't required, connect DE to V_{CC} through a $1\text{k}\Omega$ to $3\text{k}\Omega$ resistor.
4	DI	Driver input. A low on DI forces output Y low and output Z high. Similarly, a high on DI forces output Y high and output Z low.
5	GND	Ground connection.
6	A/Y	$\pm 15\text{kV}$ IEC61000 ESD Protected RS-485/422 level, noninverting receiver input and noninverting driver output. Pin is an input if DE = 0; pin is an output if DE = 1.
7	B/Z	$\pm 15\text{kV}$ IEC61000 ESD Protected RS-485/422 level, Inverting receiver input and inverting driver output. Pin is an input if DE = 0; pin is an output if DE = 1.
8	VCC	System power supply input (3.0V to 3.6V).

ISL3178AE

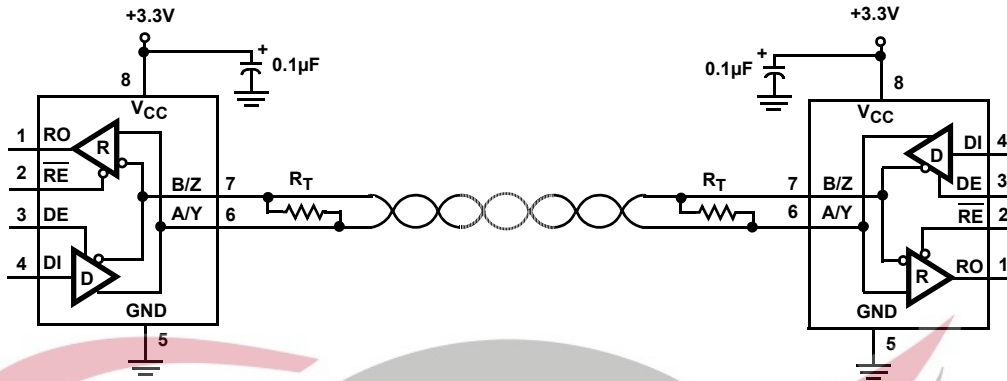


FIGURE 1. TYPICAL APPLICATION CIRCUIT

Truth Tables

TRANSMITTING				
INPUTS			OUTPUTS	
\overline{RE}	DE	DI	Z	Y
X	1	1	0	1
X	1	0	1	0
0	0	X	High-Z	High-Z
1	0	X	High-Z *	High-Z *

NOTE: *Shutdown Mode (see [Note 12](#))

Truth Tables (continued)

RECEIVING				
INPUTS				OUTPUT
\overline{RE}	DE Half Duplex	DE Full Duplex	A-B	RO
0	0	X	$\geq -0.05V$	1
0	0	X	$\leq -0.2V$	0
0	0	X	Inputs Open/Shorted	1
1	0	0	X	High-Z *
1	1	1	X	High-Z

NOTE: *Shutdown Mode (see [Note 12](#))



Absolute Maximum Ratings

V _{CC} to GND	7V
Input Voltages	
DI, DE, \overline{RE}	-0.3V to 7V
Input/Output Voltages	
A/Y, B/Z	-8V to +13V
RO	-0.3V to (V _{CC} + 0.3V)
Short Circuit Duration	
Y, Z	Continuous
ESD Rating	See "ESD PERFORMANCE" on page 5

Thermal Information

Thermal Resistance (Typical)	θ_{JA} (°C/W)	θ_{JC} (°C/W)
8 Ld SOIC Package (Notes 4, 5)	120	56
Maximum Junction Temperature (Plastic Package)	+150°C	
Maximum Storage Temperature Range	-65°C to +150°C	
Pb-Free Reflow Profile	see TB493	

Operating Conditions

Temperature Range	-55°C to +125°C
-------------------------	-----------------

CAUTION: Do not operate at or near the maximum ratings listed for extended periods of time. Exposure to such conditions may adversely impact product reliability and result in failures not covered by warranty.

NOTES:

- θ_{JA} is measured with the component mounted on a high effective thermal conductivity test board in free air. See Tech Brief [TB379](#) for details.
- For θ_{JC} , the "case temp" location is taken at the package top center.

Electrical Specifications Test Conditions: V_{CC} = 3.0V to 3.6V; Unless Otherwise Specified. Typicals are at V_{CC} = 3.3V, T_A = +25°C, (Note 7).

PARAMETER	SYMBOL	TEST CONDITIONS	TEMP (°C)	MIN (Note 6)	TYP	MAX (Note 6)	UNITS	
DC CHARACTERISTICS								
Driver Differential V _{OUT}	V _{OD}	R _L = 100Ω (RS-422) (Note 2A), (Note 16)	Full	2	2.3	-	V	
		R _L = 54Ω (RS-485) (Figure 2A)	Full	1.5	2	V _{CC}	V	
		No Load		-	-	V _{CC}		
		R _L = 60Ω, -7V ≤ V _{CM} ≤ 12V (Figure 2B)	Full	1.5	2.2	-	V	
Change in Magnitude of Driver Differential V _{OUT} for Complementary Output States	ΔV _{OD}	R _L = 54Ω or 100Ω (Figure 2A)	Full	-	0.01	0.2	V	
Driver Common-mode V _{OUT}	V _{OC}	R _L = 54Ω or 100Ω (Figure 2A)	Full	-	2	3	V	
Change in Magnitude of Driver Common-mode V _{OUT} for Complementary Output States	ΔV _{OC}	R _L = 54Ω or 100Ω (Figure 2A)	Full	-	0.01	0.2	V	
Logic Input High Voltage	V _{IH}	DI, DE, \overline{RE}	Full	2	-	-	V	
Logic Input Low Voltage	V _{IL}	DI, DE, \overline{RE}	Full	-	-	0.8	V	
Logic Input Hysteresis	V _{HYS}	DE, \overline{RE} (Note 17)	25	-	100	-	mV	
Logic Input Current	I _{IN1}	DI = DE = \overline{RE} = 0V or V _{CC} (Note 18)	Full	-2	-	2	μA	
Input Current (A/Y, B/Z)	I _{IN2}	DE = 0V, V _{CC} = 0V or 3.6V	V _{IN} = 12V	Full	-	80	125	μA
			V _{IN} = -7V	Full	-100	-50	-	μA
Driver Short-circuit Current, V _O = High or Low	I _{OSD1}	DE = V _{CC} , -7V ≤ V _Y or V _Z ≤ 12V (Note 9)	Full	-	-	±250	mA	
Receiver Differential Threshold Voltage	V _{TH}	-7V ≤ V _{CM} ≤ 12V (Note 17)	Full	-200	-125	-50	mV	
Receiver Input Hysteresis	ΔV _{TH}	V _{CM} = 0V	25	-	15	-	mV	
Receiver Output High Voltage	V _{OH}	I _O = -4mA, V _{ID} = -50mV	Full	V _{CC} - 0.6	-	-	V	
Receiver Output Low Voltage	V _{OL}	I _O = -4mA, V _{ID} = -200mV	Full	-	0.17	0.4	V	
Three-state (High Impedance) Receiver Output Current	I _{OZR}	0.4V ≤ V _O ≤ 2.4V	Full	-1	0.015	1	μA	
Receiver Input Resistance	R _{IN}	-7V ≤ V _{CM} ≤ 12V	Full	96	150	-	kΩ	
Receiver Short-Circuit Current	I _{OSR}	0V ≤ V _O ≤ V _{CC}	Full	±7	30	±60	mA	

Electrical Specifications Test Conditions: $V_{CC} = 3.0V$ to $3.6V$; Unless Otherwise Specified. Typicals are at $V_{CC} = 3.3V$, $T_A = +25^\circ C$, (Note 7).

PARAMETER	SYMBOL	TEST CONDITIONS	TEMP (°C)	MIN (Note 6)	TYP	MAX (Note 6)	UNITS
SUPPLY CURRENT							
No-load Supply Current (Note 8)	I_{CC}	DI = 0V or V_{CC}	DE = V_{CC} , RE = 0V or V_{CC}	Full	-	510	800 μA
			DE = 0V, RE = 0V	Full	-	480	700 μA
Shutdown Supply Current	I_{SHDN}	DE = 0V, RE = V_{CC} , DI = 0V or V_{CC}	Full	-	0.01	12	μA
ESD PERFORMANCE							
RS-485 Pins (A/Y, B/Z)		IEC61000-4-2, Air-gap Discharge Method	25	-	± 15	-	kV
		IEC61000-4-2, Contact Discharge Method	25	-	± 8	-	kV
		Human Body Model, From Bus Pins to GND	25	-	± 15	-	kV
All Pins		HBM, per MIL-STD-883 Method 3015	25	-	± 7	-	kV
		Machine Model	25	-	200	-	V
DRIVER SWITCHING CHARACTERISTICS (ISL3178AE)							
Maximum Data Rate	f_{MAX}	$V_{OD} = \pm 1.5V$, $C_D = 350pF$ (Figure 5) (Note 17)	Full	-	10	-	Mbps
Driver Differential Output Delay	t_{DD}	$R_{DIFF} = 54\Omega$, $C_D = 50pF$ (Figure 3)	Full	-	27	40	ns
Driver Differential Output Skew	t_{SKEW}	$R_{DIFF} = 54\Omega$, $C_D = 50pF$ (Figure 3)	Full	-	1	3	ns
Driver Output Skew, Part-to-Part	Δt_{DSKEW}	$R_{DIFF} = 54\Omega$, $C_D = 50pF$ (Figure 3) (Notes 15, 17)	Full	-	-	11	ns
Driver Differential Rise or Fall Time	t_R, t_F	$R_{DIFF} = 54\Omega$, $C_D = 50pF$ (Figure 3)	Full	-	9	15	ns
Driver Enable to Output High	t_{ZH}	$R_L = 500\Omega$, $C_L = 50pF$, SW = GND (Figure 4), (Note 10)	Full	-	17	50	ns
Driver Enable to Output Low	t_{ZL}	$R_L = 500\Omega$, $C_L = 50pF$, SW = V_{CC} (Figure 4), (Note 10)	Full	-	16	40	ns
Driver Disable from Output High	t_{HZ}	$R_L = 500\Omega$, $C_L = 50pF$, SW = GND (Figure 4)	Full	-	25	40	ns
Driver Disable from Output Low	t_{LZ}	$R_L = 500\Omega$, $C_L = 50pF$, SW = V_{CC} (Figure 4),	Full	-	28	50	ns
Time to Shutdown	t_{SHDN}	(Notes 12, 17)	Full	50	200	600	ns
Driver Enable from Shutdown to Output High	$t_{ZH(SHDN)}$	$R_L = 500\Omega$, $C_L = 50pF$, SW = GND (Figure 4), (Notes 12, 13)	Full	-	180	700	ns
Driver Enable from Shutdown to Output Low	$t_{ZL(SHDN)}$	$R_L = 500\Omega$, $C_L = 50pF$, SW = V_{CC} (Figure 4), (Notes 12, 13)	Full	-	90	700	ns
RECEIVER SWITCHING CHARACTERISTICS (ISL3178AE)							
Maximum Data Rate	f_{MAX}	$V_{ID} = \pm 1.5V$ (Note 17)	Full	-	10	-	Mbps
Receiver Input to Output Delay	t_{PLH}, t_{PHL}	(Figure 6)	Full	25	33	65	ns
Receiver Skew $t_{PLH} - t_{PHL}$	t_{SKD}	(Figure 6)	Full	-	1.5	10	ns
Receiver Skew, Part-to-Part	Δt_{RSKEW}	(Figure 6), (Notes 15, 17)	Full	-	-	15	ns
Receiver Enable to Output High	t_{ZH}	$R_L = 1k\Omega$, $C_L = 15pF$, SW = GND (Figure 7), (Note 11)	Full	5	11	17	ns
Receiver Enable to Output Low	t_{ZL}	$R_L = 1k\Omega$, $C_L = 15pF$, SW = V_{CC} (Figure 7), (Note 11)	Full	5	11	17	ns
Receiver Disable from Output High	t_{HZ}	$R_L = 1k\Omega$, $C_L = 15pF$, SW = GND (Figure 7),	Full	4	7	15	ns
Receiver Disable from Output Low	t_{LZ}	$R_L = 1k\Omega$, $C_L = 15pF$, SW = V_{CC} (Figure 7),	Full	4	7	15	ns
Time to Shutdown	t_{SHDN}	(Notes 12, 17)	Full	50	180	600	ns

Electrical Specifications Test Conditions: $V_{CC} = 3.0V$ to $3.6V$; Unless Otherwise Specified. Typicals are at $V_{CC} = 3.3V$, $T_A = +25^\circ C$, (Note 7).

PARAMETER	SYMBOL	TEST CONDITIONS	TEMP (°C)	MIN (Note 6)	TYP	MAX (Note 6)	UNITS
Receiver Enable from Shutdown to Output High	$t_{ZH}(SHDN)$	$R_L = 1k\Omega$, $C_L = 15pF$, SW = GND (Figure 7), (Notes 12, 14)	Full	-	240	500	ns
Receiver Enable from Shutdown to Output Low	$t_{ZL}(SHDN)$	$R_L = 1k\Omega$, $C_L = 15pF$, SW = V_{CC} (Figure 7), (Notes 12, 14)	Full	-	240	500	ns

NOTES:

- Parameters with MIN and/or MAX limits are 100% tested at $+25^\circ C$, unless otherwise specified. Temperature limits established by characterization and are not production tested.
- All currents into device pins are positive; all currents out of device pins are negative. All voltages are referenced to device ground unless otherwise specified.
- Supply current specification is valid for loaded drivers when $DE = 0V$.
- Applies to peak current. See "Typical Performance Curves" starting on page 10 for more information.
- When testing devices with the shutdown feature, keep $\overline{RE} = 0$ to prevent the device from entering SHDN.
- When testing devices with the shutdown feature, the \overline{RE} signal high time must be short enough (typically $<100ns$) to prevent the device from entering SHDN.
- Versions with a shutdown feature are put into shutdown by bringing \overline{RE} high and DE low. If the inputs are in this state for less than 50ns, the parts are guaranteed not to enter shutdown. If the inputs are in this state for at least 600ns, the parts are guaranteed to have entered shutdown. See "Low Power Shutdown Mode" on page 10.
- Keep $\overline{RE} = V_{CC}$, and set the DE signal low time $>600ns$ to ensure that the device enters SHDN.
- Set the \overline{RE} signal high time $>600ns$ to ensure that the device enters SHDN.
- Δt_{SKEW} is the magnitude of the difference in propagation delays of the specified terminals of two units tested with identical test conditions (V_{CC} , temperature, etc.).
- $V_{CC} \geq 3.15V$
- Limits established by characterization and are not production tested.
- If the Tx or Rx enable function isn't needed, connect the enable pin to the appropriate supply (see "Pin Descriptions" on page 2) through a $1k\Omega$ to $3k\Omega$ resistor.

Test Circuits and Waveforms

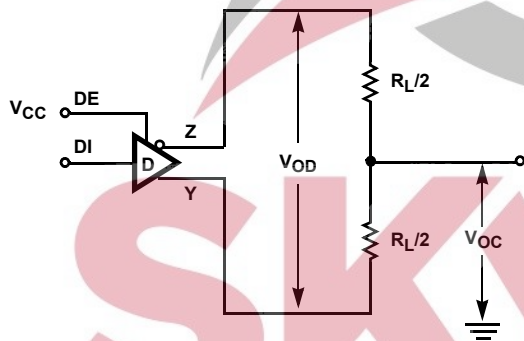
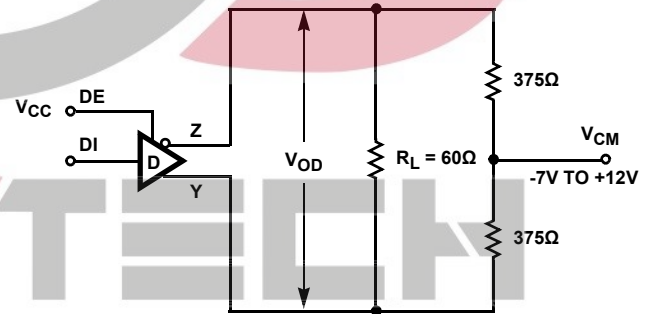
FIGURE 2A. V_{OD} AND V_{OC} FIGURE 2B. V_{OD} WITH COMMON MODE LOAD

FIGURE 2. DC DRIVER TEST CIRCUITS

Test Circuits and Waveforms (Continued)

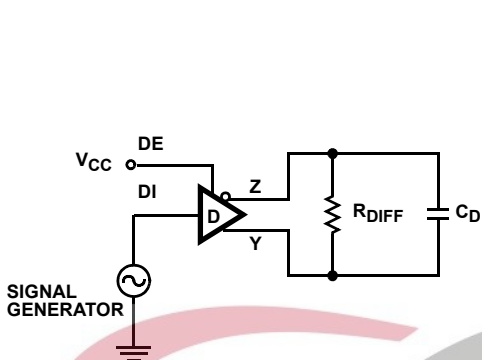


FIGURE 3A. TEST CIRCUIT

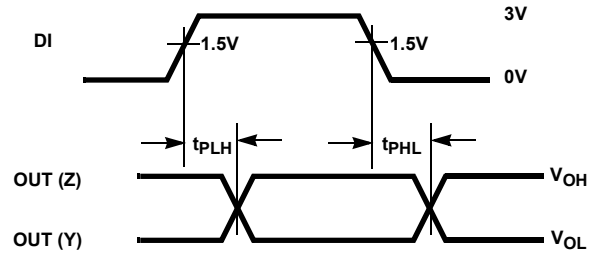


FIGURE 3B. MEASUREMENT POINTS

FIGURE 3. DRIVER PROPAGATION DELAY AND DIFFERENTIAL TRANSITION TIMES

$$SKEW = |t_{PLH} - t_{PHL}|$$

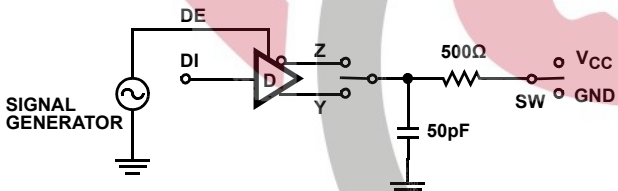


FIGURE 4A. TEST CIRCUIT

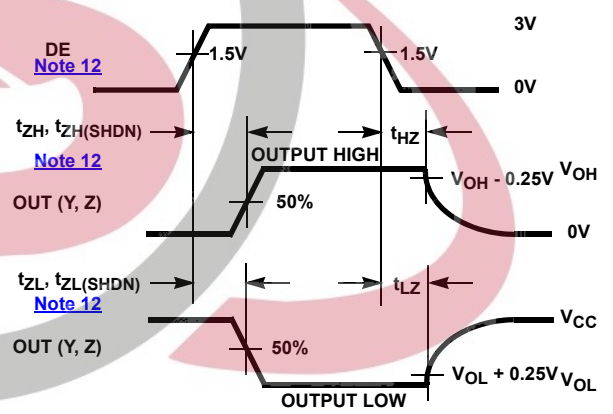


FIGURE 4B. MEASUREMENT POINTS

FIGURE 4. DRIVER ENABLE AND DISABLE TIMES

PARAMETER	OUTPUT	RE	DI	SW
t_{HZ}	Y/Z	X	1/0	GND
t_{LZ}	Y/Z	X	0/1	V_{CC}
t_{ZH}	Y/Z	0 (Note 10)	1/0	GND
t_{ZL}	Y/Z	0 (Note 10)	0/1	V_{CC}
$t_{ZH(SHDN)}$	Y/Z	1 (Note 13)	1/0	GND
$t_{ZL(SHDN)}$	Y/Z	1 (Note 13)	0/1	V_{CC}

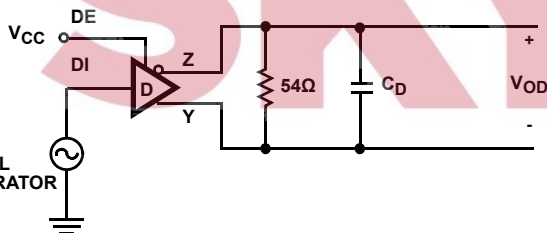


FIGURE 5A. TEST CIRCUIT

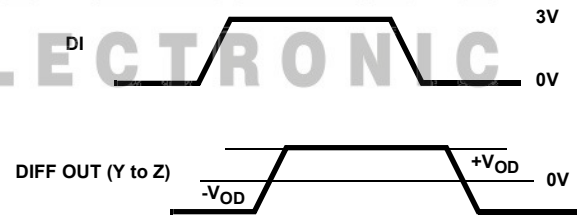


FIGURE 5B. MEASUREMENT POINTS

FIGURE 5. DRIVER DATA RATE

Test Circuits and Waveforms (Continued)

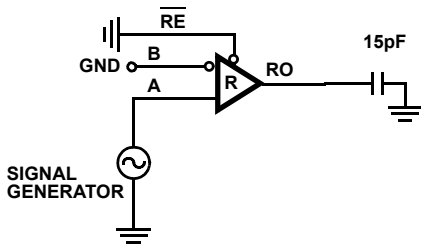


FIGURE 6A. TEST CIRCUIT

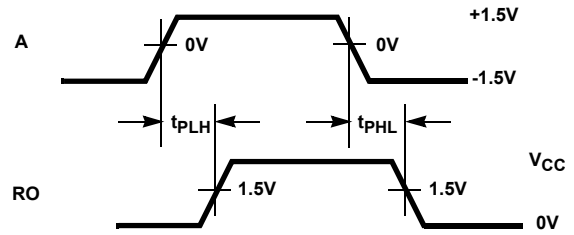
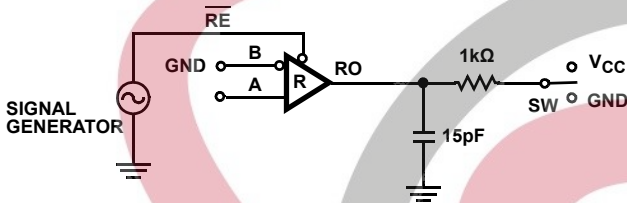


FIGURE 6B. MEASUREMENT POINTS

FIGURE 6. RECEIVER PROPAGATION DELAY



PARAMETER	DE	A	SW
t_{HZ}	X	+1.5V	GND
t_{LZ}	X	-1.5V	V_{CC}
t_{ZH} (Note 11)	0	+1.5V	GND
t_{ZL} (Note 11)	0	-1.5V	V_{CC}
$t_{ZH(SHDN)}$ (Note 14)	0	+1.5V	GND
$t_{ZL(SHDN)}$ (Note 14)	0	-1.5V	V_{CC}

FIGURE 7A. TEST CIRCUIT

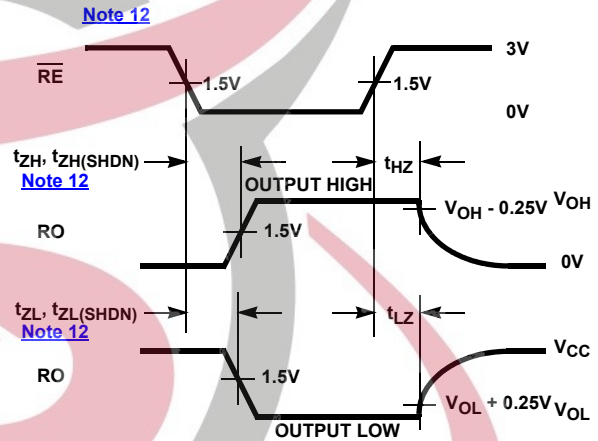


FIGURE 7B. MEASUREMENT POINTS

FIGURE 7. RECEIVER ENABLE AND DISABLE TIMES

Application Information

RS-485 and RS-422 are differential (balanced) data transmission standards for use in long haul or noisy environments. RS-422 is a subset of RS-485, so RS-485 transceivers are also RS-422 compliant. RS-422 is a point-to-multipoint (multidrop) standard, which allows only one driver and up to 10 (assuming one unit load devices) receivers on each bus. RS-485 is a true multipoint standard, which allows up to 32 one-unit load devices (any combination of drivers and receivers) on each bus. To allow for multipoint operation, the RS-485 spec requires that drivers must handle bus contention without sustaining any damage.

Another important advantage of RS-485 is the extended common mode range (CMR), which specifies that the driver outputs and receiver inputs withstand signals that range from +12V to -7V. RS-422 and RS-485 are intended for long runs, thus the wide CMR is necessary to handle ground potential differences, as well as voltages induced in the cable by external fields.

Receiver Features

This device utilizes a differential input receiver for maximum noise immunity and common mode rejection. The Input sensitivity is better than $\pm 200\text{mV}$, as required by the RS-422 and RS-485 specifications.

Receiver input resistance of $96\text{k}\Omega$ surpasses the RS-422 spec of $4\text{k}\Omega$ and is eight times the RS-485 “Unit Load (UL)” requirement of $12\text{k}\Omega$ minimum. Thus, these products are known as “one-eighth UL” transceivers and there can be up to 256 of these devices on a network while still complying with the RS-485 loading specification.

Receiver inputs function with common mode voltages as great as $+9\text{V}/-7\text{V}$ outside the power supplies (i.e., $+12\text{V}$ and -7V), making them ideal for long networks where induced voltages and ground potential differences are realistic concerns.

All the receivers include a “Full Fail-Safe” function that guarantees a high level receiver output if the receiver inputs are unconnected (floating) or shorted. Fail-safe with shorted inputs is achieved by setting the Rx upper switching point to -50mV , thereby ensuring that the Rx sees 0V differential as a high input level.

Receivers easily meet the data rates supported by the corresponding driver, and all receiver outputs are tri-statable via the active low $\overline{\text{RE}}$ input.

Driver Features

The RS-485/422 driver is a differential output device that delivers at least 1.5V across a 54 Ω load (RS-485) and at least 2V across a 100 Ω load (RS-422). The drivers feature low propagation delay skew to maximize bit width and to minimize EMI.

The drivers is tri-statable via the active high DE input. Outputs of the ISL3178AE drivers are not limited, so faster output transition times allow data rates of at least 10Mbps.

Hot Plug Function

When a piece of equipment powers up, there is a period of time where the processor or ASIC driving the RS-485 control lines (DE, RE) is unable to ensure that the RS-485 Tx and Rx outputs are kept disabled. If the equipment is connected to the bus, a driver activating prematurely during power-up may crash the bus. To avoid this scenario, the ISL3178AE versions with output enable pins incorporate a "Hot Plug" function. During power-up, circuitry monitoring V_{CC} ensures that the Tx and Rx outputs remain disabled for a period of time, regardless of the state of DE and RE. This gives the processor/ASIC a chance to stabilize and drive the RS-485 control lines to the proper states.

ESD Protection

All pins on this device includes class 3 (>7kV) Human Body Model (HBM) ESD protection structures, but the RS-485 pins (driver outputs and receiver inputs) incorporate advanced structures allowing them to survive ESD events in excess of ± 15 kV HBM and ± 15 kV IEC61000. The RS-485 pins are particularly vulnerable to ESD damage because they typically connect to an exposed port on the exterior of the finished product. Simply touching the port pins, or connecting a cable, can cause an ESD event that might destroy unprotected ICs. These new ESD structures protect the device whether or not it is powered up, and without degrading the RS-485 common mode range of -7V to +12V. This built-in ESD protection eliminates the need for board level protection structures (e.g., transient suppression diodes), and the associated, undesirable capacitive load they present.

IEC61000-4-2 Testing

The IEC61000 test method applies to finished equipment, rather than to an individual IC. Therefore, the pins most likely to suffer an ESD event are those that are exposed to the outside world (the RS-485 pins in this case), and the IC is tested in its typical application configuration (power applied) rather than testing each pin-to-pin combination. The lower current limiting resistor coupled with the larger charge storage capacitor yields a test that is much more severe than the HBM test. The extra ESD protection built into this device's RS-485 pins allows the design of equipment meeting level 4 criteria without the need for additional board level protection on the RS-485 port.

AIR-GAP DISCHARGE TEST METHOD

For this test method, a charged probe tip moves toward the IC pin until the voltage arcs to it. The current waveform delivered to the IC pin depends on approach speed, humidity, temperature, etc. so it is difficult to obtain repeatable results. The ISL3178AE RS-485 pins withstand ± 15 kV air-gap discharges.

CONTACT DISCHARGE TEST METHOD

During the contact discharge test, the probe contacts the tested pin before the probe tip is energized, thereby eliminating the variables associated with the air-gap discharge. The result is a more repeatable and predictable test, but equipment limits prevent testing devices at voltages higher than ± 8 kV. The ISL3178AE survives ± 8 kV contact discharges on the RS-485 pins.

Data Rate, Cables, and Terminations

The RS-485/422 are intended for network lengths up to 4000, but the maximum system data rate decreases as the transmission length increases. The device operates at 10Mbps are limited to lengths less than 100.

Twisted pair is the cable of choice for RS-485/422 networks. Twisted pair cables tend to pick up noise and other electromagnetically induced voltages as common mode signals, which are effectively rejected by the differential receivers in these ICs.

Proper termination is imperative to minimize reflections. Short networks using the 250kbps versions need not be terminated, but, terminations are recommended unless power dissipation is an overriding concern.

In point-to-point, or point-to-multipoint (single driver on bus) networks, the main cable should be terminated in its characteristic impedance (typically 120 Ω) at the end farthest from the driver. In multireceiver applications, stubs connecting receiver to the main cable should be kept as short as possible. Multipoint (multidriver) systems require that the main cable be terminated in its characteristic impedance at both ends. Stubs connecting a transceiver to the main cable should be kept as short as possible.

Built-In Driver Overload Protection

As stated previously, the RS-485 spec requires that drivers survive worst case bus contentions undamaged. These devices meet this requirement via driver output short circuit current limit circuitry.

The driver output stages incorporate short circuit current limiting circuitry, which ensures that the output current never exceeds the RS-485 spec, even at the common mode voltage range extremes. Additionally, these devices utilize a foldback circuit which reduces the short circuit current, and thus the power dissipation, whenever the contending voltage exceeds either supply.

Low Power Shutdown Mode

This CMOS transceiver all uses a fraction of the power required by its bipolar counterparts, but it also includes a shutdown feature that reduces the already low quiescent I_{CC} to a 10nA trickle. This device enters shutdown whenever the receiver and driver are *simultaneously* disabled ($\overline{RE} = V_{CC}$ and $DE = GND$) for a period of at least 600ns. Disabling both the driver and the

receiver for less than 50ns guarantees that the transceiver will not enter shutdown.

Note that receiver and driver enable times increase when the transceiver enables from shutdown. Refer to [Notes 10](#) through [14](#), at the end of the "Electrical Specification table" on [page 6](#), for more information.

Typical Performance Curves

$V_{CC} = 3.3V, T_A = +25^\circ C$; Unless Otherwise Specified.

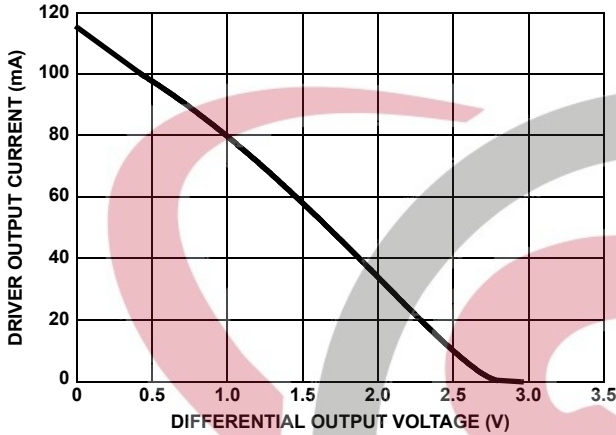


FIGURE 8. DRIVER OUTPUT CURRENT vs DIFFERENTIAL OUTPUT VOLTAGE

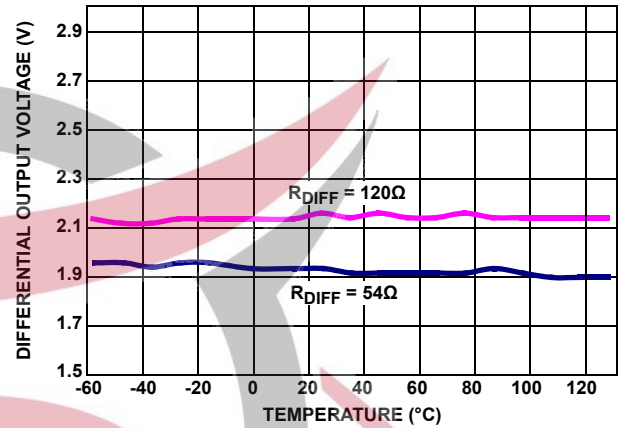


FIGURE 9. DRIVER DIFFERENTIAL OUTPUT VOLTAGE vs TEMPERATURE

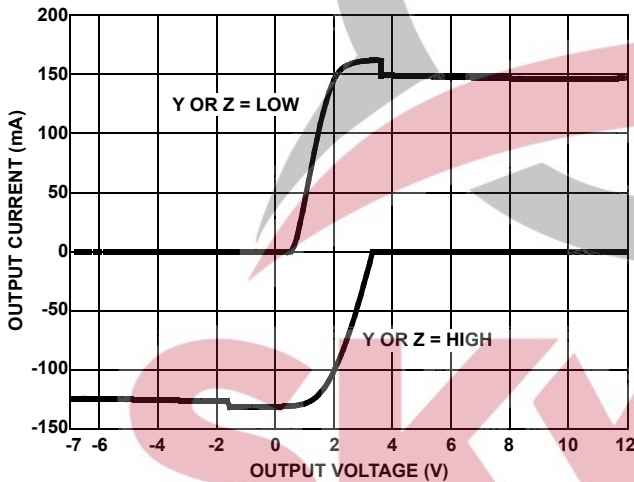


FIGURE 10. DRIVER OUTPUT CURRENT vs SHORT CIRCUIT VOLTAGE

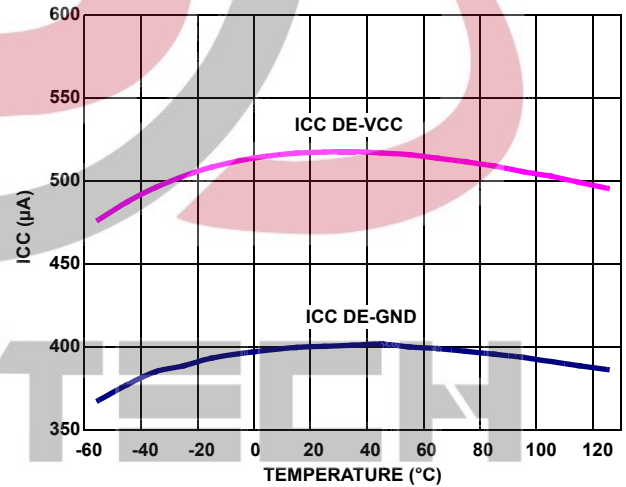


FIGURE 11. SUPPLY CURRENT vs TEMPERATURE

Typical Performance Curves

$V_{CC} = 3.3V, T_A = +25^\circ C$; Unless Otherwise Specified. (Continued)

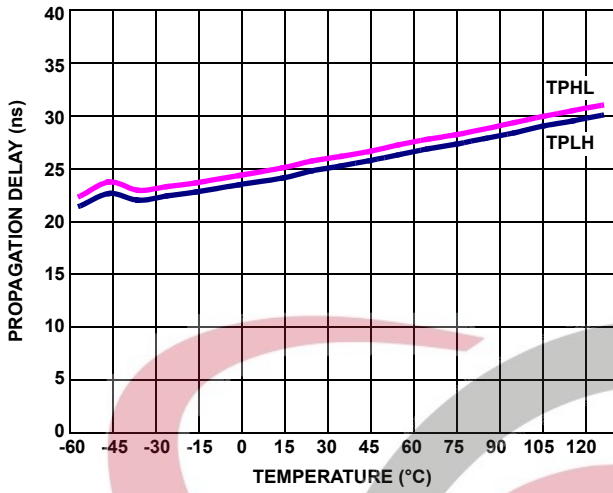


FIGURE 12. DRIVER DIFFERENTIAL PROPAGATION DELAY vs TEMPERATURE)

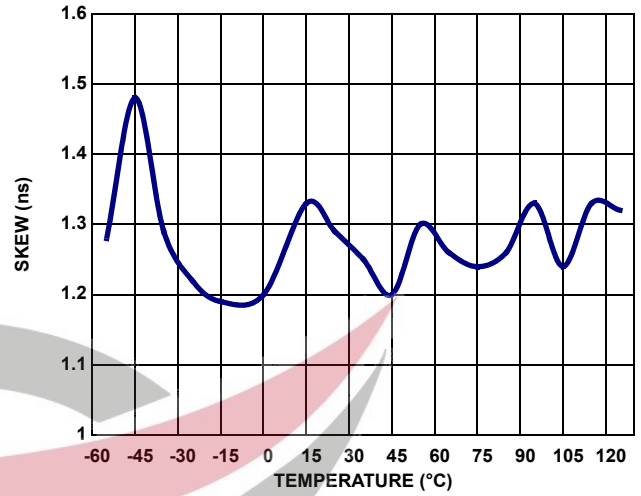


FIGURE 13. DRIVER DIFFERENTIAL SKEW vs TEMPERATURE

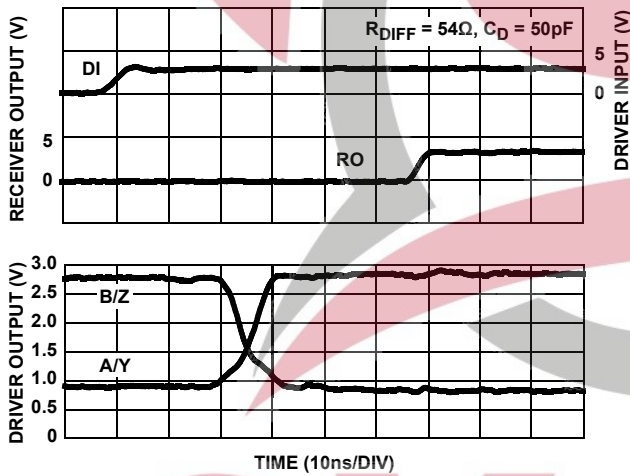


FIGURE 14. DRIVER AND RECEIVER WAVEFORMS, LOW-TO-HIGH

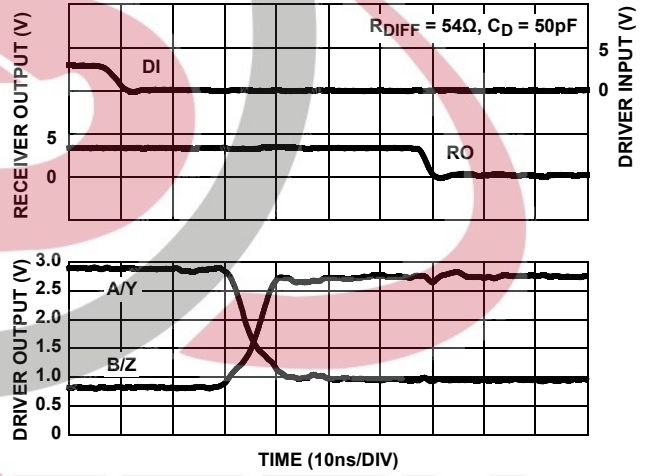


FIGURE 15. DRIVER AND RECEIVER WAVEFORMS, HIGH-TO-LOW

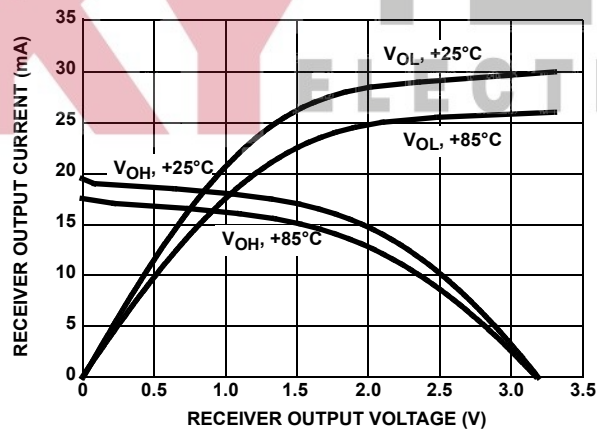


FIGURE 16. RECEIVER OUTPUT CURRENT vs RECEIVER OUTPUT VOLTAGE

Die Characteristics

DIE DIMENSIONS

Thickness: 14 mils
1295µm x 1350µm

Interface Materials

GLASSIVATION

Sandwich TEOS & Nitride

TOP METALLIZATION:

Type: Al with 0.5% Cu
Thickness: 28kÅ

SUBSTRATE

N/A

BACKSIDE FINISH

Silicon/Polysilicon/Oxide

Assembly Related Information

SUBSTRATE POTENTIAL

GND (powered up)

Additional Information

WORST CASE CURRENT DENSITY

N/A

PROCESS

Si GateBiCMOS

TRANSISTOR COUNT

535

PAD OPENING SIZE

90µm x 90µm

WAFER SIZE

200mm (~8 inch)

TRANSISTOR COUNT

535



Revision History

The revision history provided is for informational purposes only and is believed to be accurate, but not warranted. Please go to the web to make sure that you have the latest revision.

DATE	REVISION	CHANGE
October 30, 2014	FN6887.3	<p>Applied Intersil's new datasheet template.</p> <p>On page 1: Changed "+125mA/-100mA" to "+125µA/-100µA". Added AN1475, "High Temperature Behavior of ISL3178AE". In Features" section, 3rd bullet, removed "(only versions . . .)" Remove 2nd entry in Table 1.</p> <p>On page 2, removed ISL3178AEMW from the Ordering Information table.</p> <p>On page 6, removed Note 19.</p> <p>On page 12, removed Table 2.</p> <p>Added revision history and About Intersil verbiage.</p>

About Intersil

Intersil Corporation is a leading provider of innovative power management and precision analog solutions. The company's products address some of the largest markets within the industrial and infrastructure, mobile computing and high-end consumer markets.

For the most updated datasheet, application notes, related documentation and related parts, please see the respective product information page found at www.intersil.com.

You may report errors or suggestions for improving this datasheet by visiting www.intersil.com/ask.

Reliability reports are also available from our website at www.intersil.com/support



All trademarks and registered trademarks are the property of their respective owners.

For additional products, see www.intersil.com/en/products.html

Intersil products are manufactured, assembled and tested utilizing ISO9001 quality systems as noted in the quality certifications found at www.intersil.com/en/support/qualandreliability.html

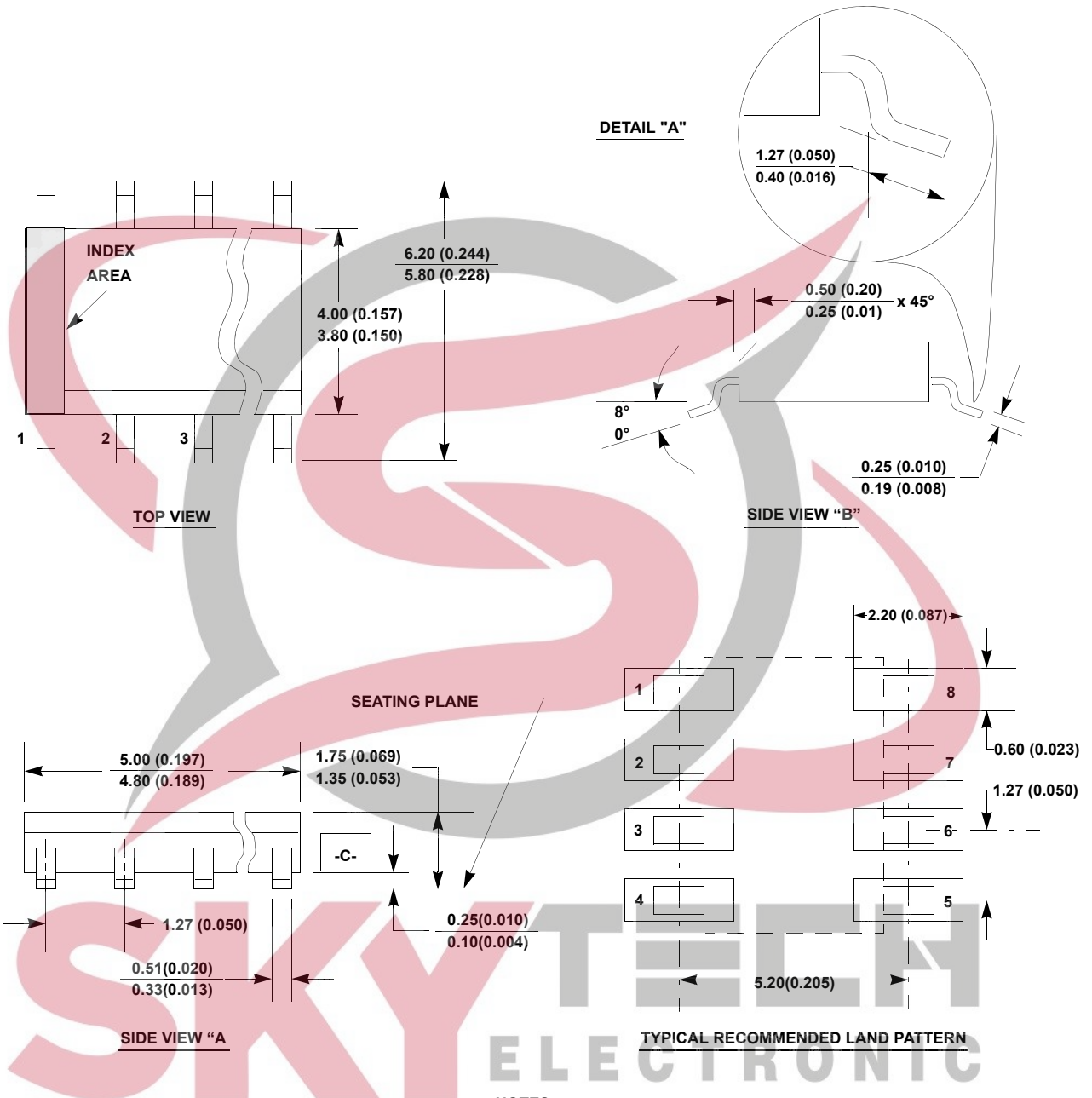
Intersil products are sold by description only. Intersil may modify the circuit design and/or specifications of products at any time without notice, provided that such modification does not, in Intersil's sole judgment, affect the form, fit or function of the product. Accordingly, the reader is cautioned to verify that datasheets are current before placing orders. Information furnished by Intersil is believed to be accurate and reliable. However, no responsibility is assumed by Intersil or its subsidiaries for its use; nor for any infringements of patents or other rights of third parties which may result from its use. No license is granted by implication or otherwise under any patent or patent rights of Intersil or its subsidiaries.

For information regarding Intersil Corporation and its products, see www.intersil.com

Package Outline Drawing M8.15

8 LEAD NARROW BODY SMALL OUTLINE PLASTIC PACKAGE

Rev 4, 1/12



NOTES:

1. Dimensioning and tolerancing per ANSI Y14.5M-1994.
2. Package length does not include mold flash, protrusions or gate burrs. Mold flash, protrusion and gate burrs shall not exceed 0.15mm (0.006 inch) per side.
3. Package width does not include interlead flash or protrusions. Interlead flash and protrusions shall not exceed 0.25mm (0.010 inch) per side.
4. The chamfer on the body is optional. If it is not present, a visual index feature must be located within the crosshatched area.
5. Terminal numbers are shown for reference only.
6. The lead width as measured 0.36mm (0.014 inch) or greater above the seating plane, shall not exceed a maximum value of 0.61mm (0.024 inch).
7. Controlling dimension: MILLIMETER. Converted inch dimensions are not necessarily exact.
8. This outline conforms to JEDEC publication MS-012-AA ISSUE C.